

DEVELOPMENT OF DIGITAL DEMODULATOR FOR LASER VIBROMETER STANDARD

A. Ota¹/Presenter, Y. Kobayashi², O. Takano² and N. Kasai²

¹National Metrology Institute of Japan, National Institute of Advanced Industrial Science and Technology, Tsukuba, Japan, a-oota@aist.go.jp

²Neoark Corporation, Tokyo, Japan

Abstract: In this study, a measurement reliability of commercial laser vibrometer with analogue demodulator is investigated for establishment of traceability system for laser vibrometer in vibration acceleration standard. As a result, a large amount of measurement deviation due to characteristics of analogue demodulator is confirmed, and in order to reduce such deviation, high accuracy digital demodulator, applicable as the reference standard, is developed. The good measurement accuracy of the developed digital demodulator was confirmed by the experiments.

Keywords: laser vibrometer, analogue demodulator, digital demodulator, ISO 16063-41

1. INTRODUCTION

Laser vibrometer has been frequently used for precise vibration measurement to ensure the safety of products in industry. The reliability and accuracy of such measurements should be guaranteed by measurement standards and a traceability system, which is an unbroken chain of calibrations from national or international standards to users' laser vibrometers. To establish such a traceability system for the laser vibrometer, a novel calibration method for the laser vibrometer has been published as a new standard (ISO 16063-41 [1]). Some demonstrations have been attempted in accordance with this standard [2-5].

Laser vibrometer consists of two key components, laser optics and a demodulator. An interferometry signal detected by laser optics is transformed into acceleration, velocity, or displacement signal by the demodulator. Two kinds of demodulator, analogue and digital type, can be applied for this transformation.

An analogue demodulator has been used for many years.

It enables direct conversion from Doppler signals to velocity signals, and velocity signals can be continuously obtained over a wide velocity or frequency range. In the analogue demodulator, the characteristics of the electric components such as FV converter, low-pass filter, and scaling amplifier strongly affect the measurement accuracy [6].

On the other hand, the digital demodulator applies a new signal processing method that does not depend on the characteristics of analogue components. The only analogue device required is an analogue-to-digital converter with high speed and high resolution, due to the wide bandwidth of the interferometry signals. In the digital demodulator, the measurement accuracy mainly depends on the characteristics of the analogue-to-digital converter and the calculation algorithm.

Therefore, the digital demodulator unit would enable users to easily obtain high measurement accuracy in contrast with the analogue demodulator. However, digital demodulator cannot always provide continuous measurement over the wide velocity or frequency range achieved by the analogue demodulator unit due to technical barriers such as the limited number of samples available for digital processing [6].

In this study, characteristics of some types of commercial laser vibrometer are investigated, and demerit of an analogue demodulator is clarified. In addition, digital demodulator, which enables continuous measurement, is developed to implement high measurement reliability.

2. CHARACTERISTICS OF COMMERCIAL LASER VIBROMETER WITH ANALOGUE DEMODULATOR

In this study, the effect of the demodulator in laser vibrometer to measurement accuracy is investigated. Three

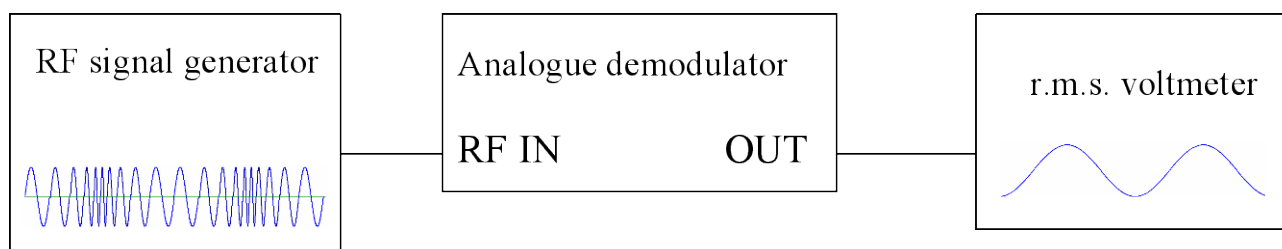

Figure 1 Experimental setup for demodulator calibration

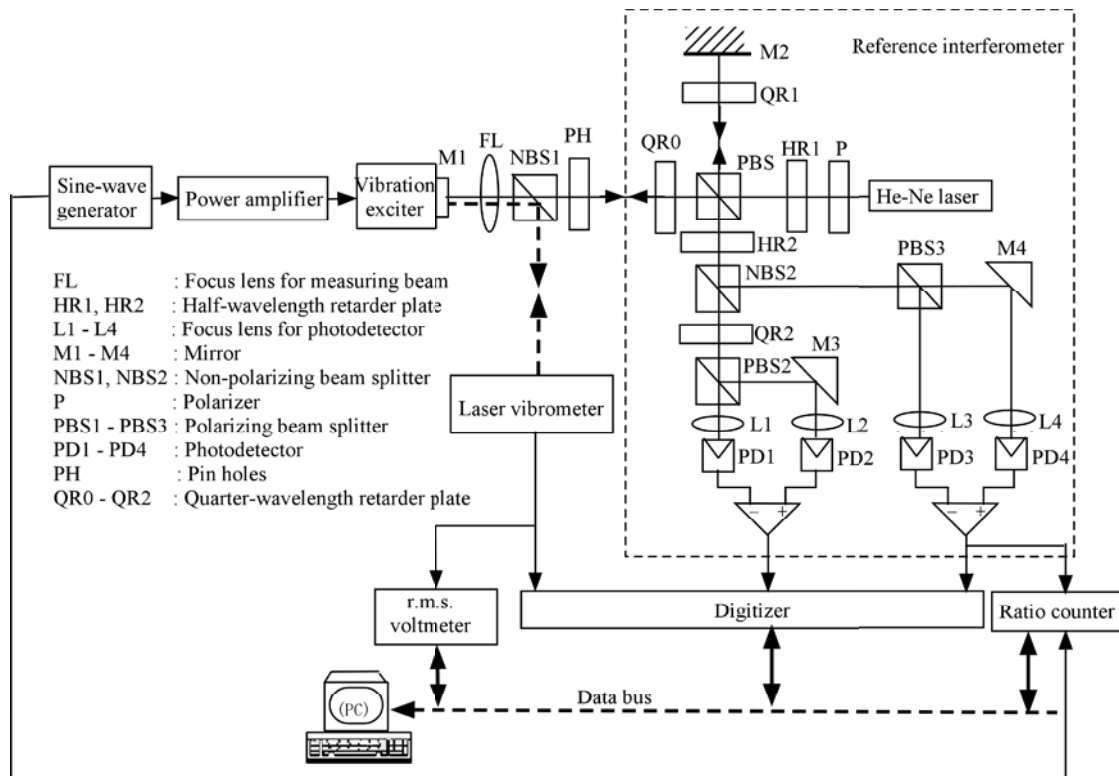

Figure 2 Experimental setup for primary calibration of laser vibrometer

different kinds of commercial laser vibrometer with analogue demodulator are applied to the experiment. Their demodulators are electrically calibrated with simulated frequency modulated signals, which are equivalent with output signals obtained from laser optics in laser vibrometer calibration in accordance with ISO 16063-41. Figure 1 shows the experimental setup for the demodulator calibration. A radio frequency signal generator is applied to generate the simulated frequency-modulated signal. An

r.m.s. voltmeter (or digitizer) measures the output voltage from the demodulator unit.

Additionally, to validate the correlation of the demodulator calibration results with laser vibrometer calibration results, primary calibration using practical vibration is also carried out in accordance with ISO 16063-41. Figure 2 shows the experimental setup for primary calibration of laser vibrometer. In this setup, the fringe counting method is applied for the frequency range of 20 Hz to 80 Hz and the sine approximation method is applied for the frequency range of 100 Hz to 5 kHz.

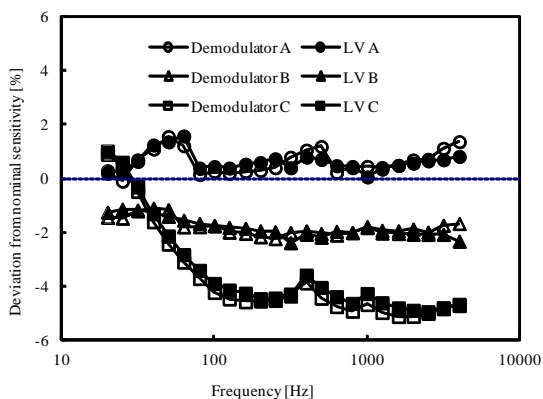

Figure 3 Comparison results between commercial laser vibrometer calibration and its demodulator calibration in three different private companies at nominal sensitivity of 10 (mm/s)/V.

A, B, and C : different manufacturers.
 LV : Laser vibrometer

Figure 3 shows comparison results between primary calibration of commercial laser vibrometers in three different private manufacturers and the electrical calibration of their demodulators. The electrical calibration results of the demodulators show extremely similar characteristics to laser vibrometer calibration results.

Figure 4 shows the primary calibration results corrected on the basis of the demodulator calibration results. Although the results from two different calibration methods had large amount of deviation of more than 1.0 % from nominal sensitivities in figure 3, a small amount of deviation of less than 0.5 % is almost achieved by correction on basis of their demodulator calibration results.

The corrected results in figure 4 would normally indicate the effect of optics part of laser vibrometer. But, the frequency characteristics corrected for three different laser vibrometers are similar to each other. Therefore, the deviation of these corrected results from nominal sensitivity would be brought not so much by the effect of optics part as by systematic error due to common component in

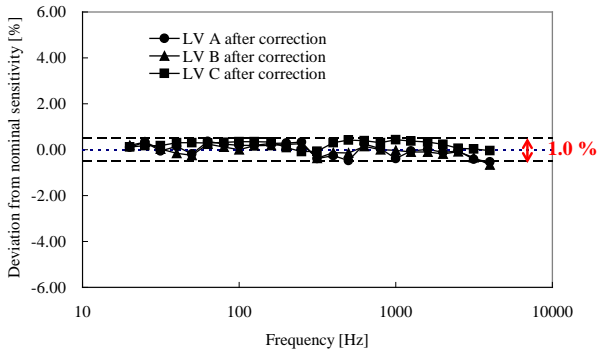

Figure 4 Correction results based on demodulator calibration

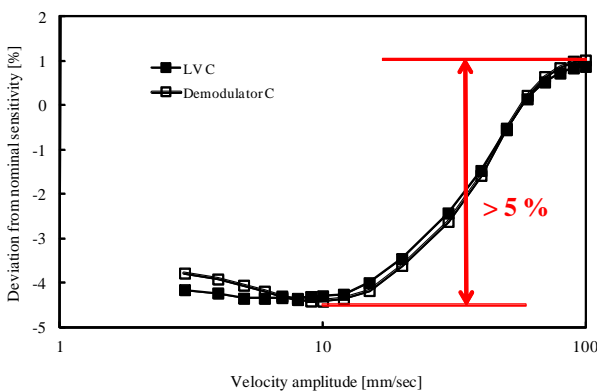

Figure 5 Typical nonlinearity for velocity amplitude at 160 Hz at nominal sensitivity of 10 (mm/sec)/V

demodulator calibration, such as simulated frequency-modulated signal from radio frequency signal generator.

As the basic principle of laser vibrometer, the frequency shift of scattered light from a moving surface by Doppler-effect is proportional to the velocity of the moving surface. Therefore, the nonlinearity for velocity amplitude might be rather remarkable than frequency characteristic. In this study, typical both characteristics are minutely evaluated by using LV C. The nominal sensitivity value is fixed during the evaluation. Figure 5 shows nonlinearity for velocity amplitude at the calibration frequency of 160 Hz. The velocity amplitude is adjusted from 3 mm/sec to 100 mm/sec. Figure 6 shows frequency characteristic at constant velocity amplitude of 10 mm/sec. As the fluctuation due to velocity amplitude is much larger than that due to the frequency, the linearity for velocity amplitude might be more important information for practical use as sensitivity of laser vibrometer. The evaluation results of the demodulator are extremely similar to the evaluation result of laser vibrometer, respectively. As a result, the drastic fluctuation of laser vibrometer sensitivity would be brought by analogue demodulator.

Consequently, to secure measurement reliability of the laser vibrometer in measurement range not covered by the primary calibration of laser vibrometer in accordance with ISO 16063-41, the appropriate electrical calibration for analogue demodulator would have big potential to extrapolate the sensitivity. But, if the more precise vibration

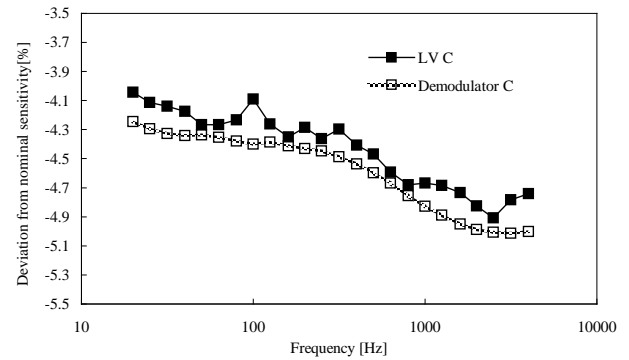

Figure 6 Typical frequency characteristic at nominal sensitivity of 10 (mm/sec)/V (velocity amplitude is fixed at 10 mm/sec)

measurement is required, the measurement accuracy of the demodulator should be improved.

3. DEVELOPMENT OF DIGITAL DEMODULATOR

In ISO 16063-41, the digital signal processing for decoding of the Doppler signal is required as the definition of laser vibrometer standards. Therefore, to develop the demodulator with higher accuracy, the potential of digital demodulation should be investigated by comparing with analogue demodulation. The comparison is carried out by using electrical calibration and primary calibration explained above in section 2.

In this experiment, LV C is used as the laser vibrometer with analogue demodulator. The optics part of LV C can be detachable from the analogue demodulator part as the LV C is specially designed. On the other hand, to conveniently achieve digital demodulation, commercial signal analyzer (Anritsu MS2690A) is applied. By using this instrument, I & Q signals (in-phase and quadrature-phase signal pair) can be easily obtained and then, decoding of the I & Q signals is carried out by our original software using LabVIEW. The signal analyzer has ADC resolution of 16 bits, max. sampling rate of 50 MHz, and RF down-conversion function.

To implement laser vibrometer with digital demodulator, the optics part of LV C is connected with the signal analyzer.

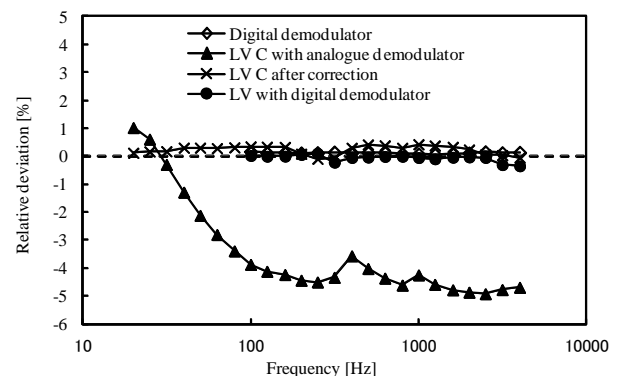

Figure 7 Preliminary comparison of digital demodulation with analogue demodulation

Figure 7 shows both experimental results of primary calibration and electrical calibration. As a result, the potential of the digital demodulator to achieve higher measurement accuracy is confirmed.

Based on this result, the digital demodulator with higher accuracy for laser vibrometer is discussed. Although the application of the signal analyzer gives good result in the preliminary experiment, the signal analyzer would be inappropriate as it cannot make continuous output in real time for practical use. So, the digital demodulator, which has a smaller deviation than commercial analogue demodulator and makes continuous output in real time, is originally designed.

The developed digital demodulator is constructed with analogue to digital converter (ADC), digital to analogue converter (DAC), and field-programmable gate array (FPGA) with low cost. The He-Ne laser is used as laser source in LV C. The driving frequency of acousto optic modulator (Bragg cell) in optics part in LV C is fixed at 80 MHz. The maximum frequency shift due to Doppler effect, which is equivalent to maximum measurable velocity, is set to 10 MHz, to cover the velocity range of below 3 m/sec. To satisfy this specification, the sampling rate of more than 200 MHz is required as maximum sampling rate of ADC. As a

result, the ADC has two channel input, high sampling rate of 500 MS/sec, and high resolution of 12 bit. The DAC has 2 channel output, high sampling rate of 250 MS/sec, and high resolution of 16 bit. The high speed signal processing is required to obtain the demodulation signal in real time as possible. FPGA can process faster than DSP. Therefore, FPGA is applied to achieve high speed signal processing for demodulation with low cost. The data processing including digital demodulation algorithm embedded in FPGA is developed to satisfy the requirement for laser vibrometer standard described in ISO 16063-41. The specifications of ADC, DAC and FPGA are given to enable continuous measurement with wide frequency range up to several hundred kHz. This digital demodulator can receive either carrier frequency signal of 80 MHz or 10 MHz, to process immediate frequency signal after down conversion. Additionally, the higher accuracy measurement can be achieved by applying an external clock of 10 MHz to this demodulator. Figure 8 shows a photograph of developed digital demodulator.

The digital demodulator is evaluated under the same experimental condition for analogue demodulator. Figure 9 and figure 10 show typical evaluation results. As a result, the relative deviation is confirmed to be below 0.3 % in



(a) Overview

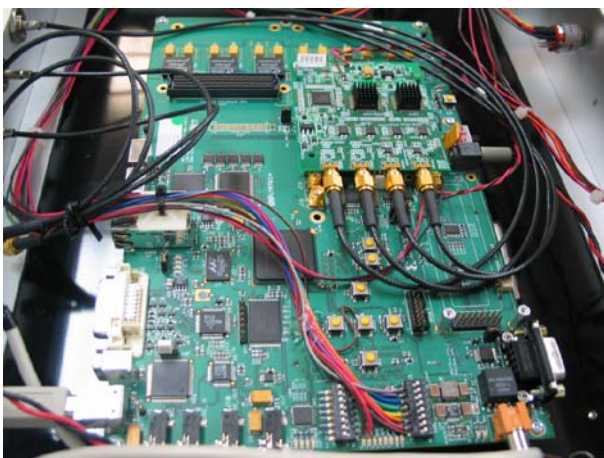

(b) Internal view
(c)

Figure 8 Photo of developed digital demodulator for laser vibrometer

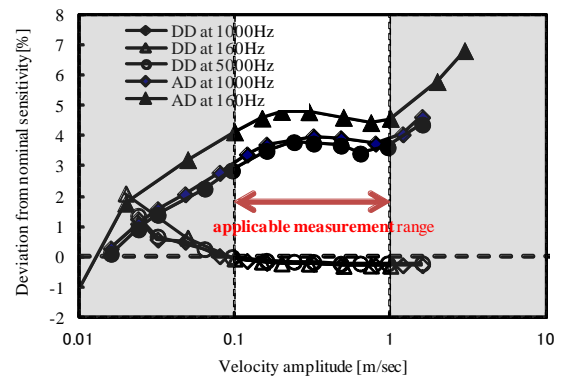

Figure 9 Typical evaluation results of relative sensitivity deviation for developed digital demodulator
DD: digital demodulator, AD: analogue demodulator

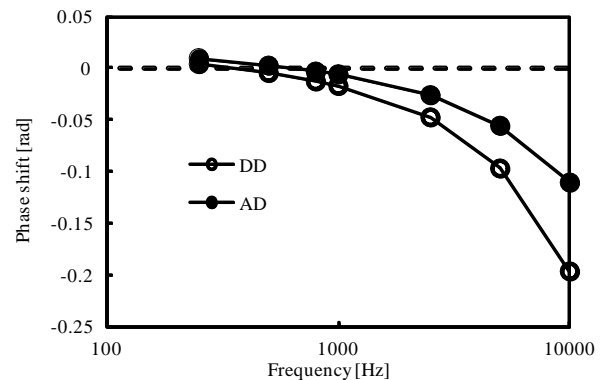

Figure 10 Typical evaluation results of phase shift for developed digital demodulator (phase shift)
DD: digital demodulator, AD: analogue demodulator

applicable measurement range, and the time delay of output due to the signal processing is evaluated to be about 30 μ sec. These results indicate that the developed digital demodulator has enough high measurement accuracy applicable as laser vibrometer standard. Finally, the digital demodulator is combined with laser optics to be laser vibrometer.

5. ACKNOWLEDGEMENT

This work was performed under management of AIST in research project to support small and medium companies, financially supported by METI (Ministry of Economy, Trade and Industry). We deeply appreciate kind cooperation with two famous Japanese manufacturers of laser vibrometers. And we also wish to thank Dr. H-J.von Martens who drafted ISO 16063-41 for this frequent communication and discussion.

6. REFERENCES

- [1] ISO 16063-41: Methods for the calibration of vibration and shock transducers – Part 41: Calibration of laser vibrometers, International Organization for Standardization (2011).
- [2] H.-J. von Martens, T. Bruns, A. Taubüner, W. Wabinski, and U. Göbel, “Recent progress in accurate vibration measurements by laser techniques”, Proc. SPIE 6345 (Proc. of the 7th International Conference on Vibration Measurements by Laser Techniques: Advances and Applications), 634501-1 to 23 (2006).
- [3] A. Oota, T. Usuda, T. Ishigami, H. Nozato, H. Aoyama, and S. Sato, “Preliminary implementation of primary calibration system for laser vibrometer”, Proc. SPIE 6345 (Proc. of the 7th International Conference on Vibration Measurements by Laser Techniques: Advances and Applications), 634503-1 to 8 (2006).
- [4] U. Buehn, and H. Nicklich, “Calibration of laser vibrometer standards according to the standardization project ISO 16063-41”, Proc. SPIE 6345 (Proc. of the 7th International Conference on Vibration Measurements by Laser Techniques: Advances and Applications), 63451F-1 to 9, (2006).
- [5] G. P. Ripper, G. A. Garcia, and R. S. Dias, “The development of a new primary calibration system for laser vibrometer at INMETRO”, Proc. of the IMEKO 20th TC 3, 3rd TC 16 and 1st TC 22 International Conference, ID-105 (2007).
- [6] M. Bauer, F. Ritter, and G. Siegmund, “High-precision laser vibrometers based on digital Doppler-signal processing”, Proc. SPIE 4827 (Proc. of the 5th International Conference on Vibration Measurements by Laser Techniques: Advances and Applications), 50-61 (2002).